

COUPLINGS, MULTICOUPLINGS & MOULD COOLING PRODUCTS

KUPPLUNGEN, MULTIKUPPLUNGEN & KÜHLUNGSELEMENTE FÜR WERKZEUGE

SERIE 6,9,16



Interchangeability - Kompatibilität

DME - FOSTER FJT, PARKER MOLDMATE, JIFFY TITE & JIFFY MATIC, RECTUS 86-87-88

Temperature Range - Temperaturbereich

-20°C +100°C (-4°F +212°F) Nitril (N)
-10°C +200°C (+14°F +392°F) Viton (V)

Working Pressure - Betriebsdruck

0 - 10 bar (0 - 145 PSI) TST 6
0 - 15 bar (0 - 217 PSI) TST 9
0 - 20 bar (0 - 290 PSI) TST 16

Flow capacity - Nennweiten

TST 6 NW 6 200 (1/4")
TST 9 NW 9 300 (3/8")
TST 16 NW 16 500 (1/2")

Standard version - Standardversion

Brass - Messing
Viton Seal - Viton Dichtung

Options - Optionen

D - Double Shut off - Beidseitig absperrend
N - Nickel plated - Vernickelt
S - Stainless Steel - Edelstahl

For optional orders please add the symbol of your option end of the order no.
Bei Bestellungen Kennbuchstabe bitte hinzufügen (Beispiel: 9 EG 13-N - S)

Material - Material

Coupler Body- Kupplungsgrundkörper	: Brass - Messing
Back Part - Rückwartiger	: Brass - Messing
Sleeve - Hülse	: Brass - Messing
Valve - Ventil	: Brass - Messing
Springs - Federn	: Stainless Steel - Edelstahl
Locking O-Ring- Sprengring	: Stainless Steel - Edelstahl
Balls - Kugeln	: Stainless Steel - Edelstahl
Seals - Dichtungen	: Viton (V)
Plug - Nippel	: Brass - Messing

* HVK sleeve is made of brass & nickel plated

Using Area:

- On cooling system of plastic zamak, brass and aluminium injection moulds
- On cleaning and washing systems of machines
- On hot oil - water lines connection
- All industries
- On steam line

Anwendungsbereiche:

- An Kühlsysteme für Kunststoff-, Zinkdruckguß, Messing- und Aluminium - Kokillenformen
- Reinigungs- und Waschsyste von Maschinen
- Temperierung (Wasser/Öl)
- Alle Industriezweige
- Dampfleitungen



SERIE **6,9,16** ■

COUPLINGS, MULTICOUPLINGS & MOULD COOLING PRODUCTS

KUPPLUNGEN, MULTIKUPPLUNGEN & KÜHLUNGSELEMENTE FÜR WERKZEUGE



Options - Optionen

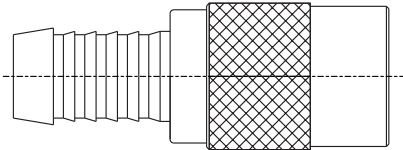

Hose Tail Options / Schlauchanschluss Option

For this type hose tail please add the FHG symbol of your option in side of the order no. For example HVK 9 **FHG 13**

Für diesen Schlauchanschluss fügen Sie FHG zur Artikelnummer hinzu. Z.B. HVK 9 **FHG 13**

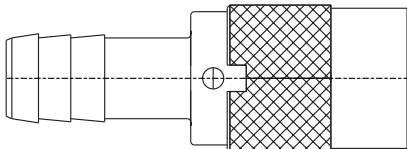

E1 Type Safety coupler / S Sicherheitsverriegelung

Please add the symbol E1 add the symbol of your option end of the order no. For example HVK 9-13-E1

Für diese Option fügen Sie E2 zur Artikelnummer hinzu. Z.B. HVK 9-13-E1

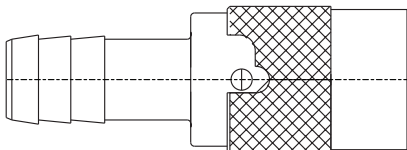

E2 Type Safety coupler / SB Sicherheitsverriegelung

Please add the symbol E2 add the symbol of your option end of the order no. For example HVK 9-13-E2

Für diese Option fügen Sie E2 zur Artikelnummer hinzu. Z.B. HVK 9-13-E2



Water / Wasser

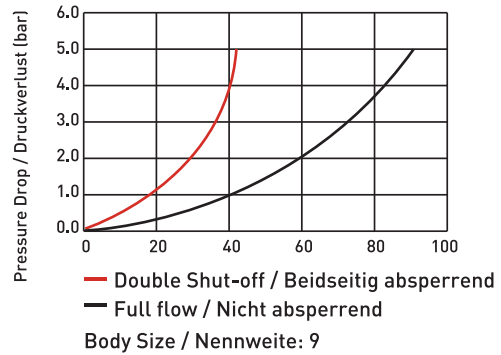

Water / Wasser

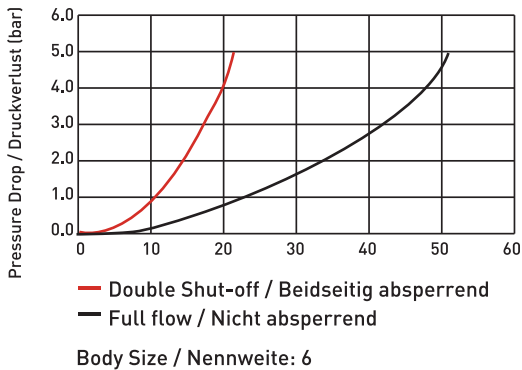

Water / Wasser

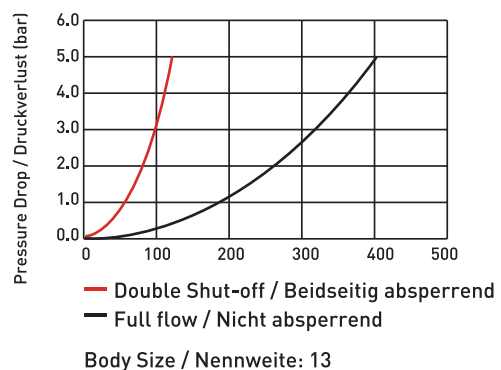

COUPLINGS, MULTICOUPLINGS & MOULD COOLING PRODUCTS

KUPPLUNGEN, MULTIKUPPLUNGEN & KÜHLUNGSELEMENTE FÜR WERKZEUGE

SERIE 6,9,16

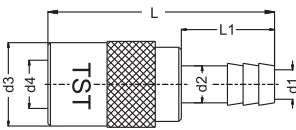

Standard hose tail socket
Kupplung mit gerader Standard - Schlauchtülle



With Valve / Mit Ventil
Order No / Bestellnr.

Without Valve / Ohne Ventil
Order No / Bestellnr.

HVK 6 - 06

HK 6 - 06

Serie	d1	d2	d3	d4	L	LI
200	4	6.3 - 1/4"	17	9.5	56.5	23.3
200	6	8 - 5/16"	17	9.5	56.5	23.3
200	7	9 - 5/14"	17	9.5	56.5	23.3
200	8	10 - 3/8"	17	9.5	56.5	23.3
300	8	10 - 3/8"	23.3	13.5	69.3	23.3
300	9	11 - 7/16"	23.3	13.5	69.3	23.3
100	10	13 - 1/2"	23.3	13.5	69.3	23.3
500	10	13 - 1/2"	32	20.1	93	27
500	13	16 - 5/8"	32	20.1	93	27
500	16	19 - 3/4"	32	20.1	93	27

HVK 6 - 08

HK 6 - 08

HVK 6 - 09

HK 6 - 09

HVK 6 - 10

HK 6 - 10

HVK 9 - 10

HK 9 - 10

HVK 9 - 11

HK 9 - 11

HVK 9 - 13

HK 9 - 13

HVK 16 - 13

HK 16 - 13

HVK 16 - 16

HK 16 - 16

HVK 16 - 19

HK 16 - 19



With Valve / Mit Ventil
Order No / Bestellnr.

Without Valve / Ohne Ventil
Order No / Bestellnr.

HVK 6 - 06 - 45°

HK 6 - 06 - 45°

HVK 6 - 08 - 45°

HK 6 - 08 - 45°

HVK 6 - 09 - 45°

HK 6 - 09 - 45°

HVK 6 - 10 - 45°

HK 6 - 10 - 45°

HVK 9 - 10 - 45°

HK 9 - 10 - 45°

HVK 9 - 11 - 45°

HK 9 - 11 - 45°

HVK 9 - 13 - 45°

HK 9 - 13 - 45°

HVK 16 - 13 - 45°

HK 16 - 13 - 45°

HVK 16 - 19 - 45°

HK 16 - 19 - 45°

HVK 16 - 16 - 45°

HK 16 - 16 - 45°

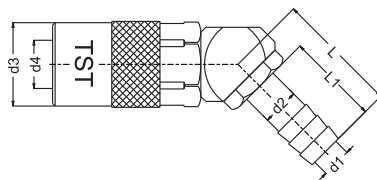

Standard hose tail socket 45°
Kupplung mit 45° Schlauchtülle



SERIE 6,9,16 ■

COUPLINGS, MULTICOUPLINGS & MOULD COOLING PRODUCTS

KUPPLUNGEN, MULTIKUPPLUNGEN & KÜHLUNGSELEMENTE FÜR WERKZEUGE

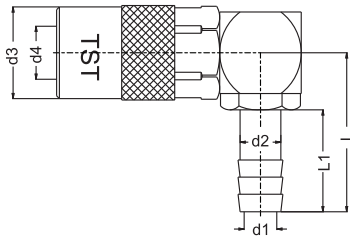

Standard hose tail socket 90°
Kupplung mit 90° Standard - Schlauchtülle

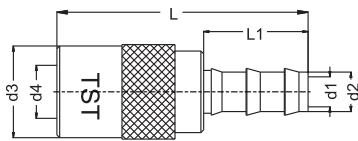

Push-Lock hose tail socket
Kupplung mit gerader Schnellsteck - Schlauchtülle

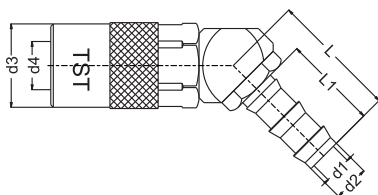

Push-Lock hose tail socket 45°
Kupplung mit 45° Schnellsteck - Schlauchtülle



With Valve / Mit Ventil
Order No / Bestellnr.

Without Valve / Ohne Ventil
Order No / Bestellnr.

Serie	d1	d2	d3	d4	L	LI
HVK 6 - 06 - 90°	4	6 - 1/4"	17	9.5	33.5	23.3
HVK 6 - 08 - 90°	6	8 - 5/16"	17	9.5	33.5	23.3
HVK 6 - 09 - 90°	7	9 - 5/14"	17	9.5	33.5	23.3
HVK 6 - 10 - 90°	8	10 - 3/8"	17	9.5	33.5	23.3
HVK 9 - 10 - 90°	8	10 - 3/8"	23.3	13.5	39.3	25.3
HVK 9 - 11 - 90°	9	11 - 7/16"	23.3	13.5	39.3	25.3
HVK 9 - 13 - 90°	10	13 - 1/2"	23.3	13.5	39.3	25.3
HVK 16 - 13 - 90°	10	13 - 1/2"	32	20.1	50	27
HVK 16 - 16 - 90°	13	16 - 5/8"	32	20.1	50	27
HVK 16 - 19 - 90°	16	19 - 3/4"	32	20.1	50	27



With Valve / Mit Ventil
Order No / Bestellnr.

Without Valve / Ohne Ventil
Order No / Bestellnr.

Serie	d1	d2	d3	d4	L	LI
HVK 6 - FG - 06	4.5	6.7 - 1/4"	17	9.5	57.8	24
HVK 6 - FG - 10	7.5	10 - 3/8"	17	9.5	57.8	28
HVK 9 - FG - 10	7.5	10 - 3/8"	23.3	13.5	70	28
HVK 9 - FG - 13	10	12.7 - 1/2"	23.3	13.5	74	38
HVK 16 - FG - 13	10	13.3 - 1/2"	32	20.1	93	38
HVK 16 - FG - 16	13	16 - 5/8"	32	20.1	103	
HVK 16 - FG - 19	16	19 - 3/4"	32	20.1	103	



With Valve / Mit Ventil
Order No / Bestellnr.

Without Valve / Ohne Ventil
Order No / Bestellnr.

Serie	d1	d2	d3	d4	L	LI
HVK 6 - FG - 06 - 45°	4.5	6.7 - 1/4"	17	9.5	29.3	24
HVK 6 - FG - 10 - 45°	7.5	10 - 3/8"	17	9.5	29.3	24
HVK 9 - FG - 10 - 45°	7.5	10 - 3/8"	23.3	13.5	36	24
HVK 9 - FG - 13 - 45°	10	12.7 - 1/2"	23.3	13.5	40	28
HVK 16 - FG - 13 - 45°	10	13.3 - 1/2"	32	20.1	43	28
HVK 16 - FG - 16 - 45°	13	16 - 5/8"	32	20.1	53	38
HVK 16 - FG - 19 - 45°	16	19 - 3/4"	32	20.1	53	38

COUPLINGS, MULTICOUPLINGS & MOULD COOLING PRODUCTS

KUPPLUNGEN, MULTIKUPPLUNGEN & KÜHLUNGSELEMENTE FÜR WERKZEUGE

SERIE 6,9,16

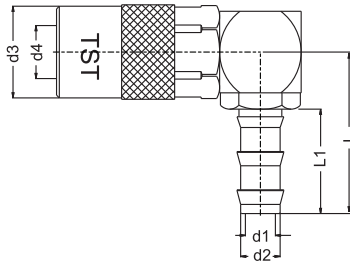

Push-Lock hose tail socket 90°
Kupplung mit 90°
Schnellsteck - Schlauchtülle



With Valve / Mit Ventil
Order No / Bestellnr.



Without Valve / Ohne Ventil
Order No / Bestellnr.

With Valve / Mit Ventil Order No / Bestellnr.	Without Valve / Ohne Ventil Order No / Bestellnr.	Serie	d1	d2	d3	d4	L	LI
HVK 6 - FG - 06 - 90°	HK 6 - FG - 06 - 90°	200	4.5	6.7 - 1/4"	17	9.5	34.7	24
HVK 6 - FG - 10 - 90°	HK 6 - FG - 10 - 90°	200	7.5	10 - 3/8"	17	9.5	34.7	24
HVK 9 - FG - 10 - 90°	HK 9 - FG - 10 - 90°	300	7.5	10 - 3/8"	23.3	13.5	40	24
HVK 9 - FG - 13 - 90°	HK 9 - FG - 13 - 90°	300	10	12.7 - 1/2"	23.3	13.5	44	28
HVK 16 - FG - 13 - 90°	HK 16 - FG - 13 - 90°	500	10	13.3 - 1/2"	32	20.1	45	28
HVK 16 - FG - 16 - 90°	HK 16 - FG - 16 - 90°	500	13	16 - 5/8"	32	20.1	55	38
HVK 16 - FG - 19 - 90°	HK 16 - FG - 19 - 90°	500	16	19 - 3/4"	32	20.1	55	38

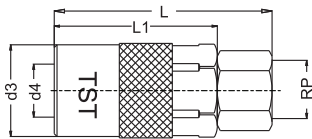

Female Thread socket
Kupplung mit Innengewinde zylindrisch BSP



With Valve / Mit Ventil
Order No / Bestellnr.



Without Valve / Ohne Ventil
Order No / Bestellnr.

With Valve / Mit Ventil Order No / Bestellnr.	Without Valve / Ohne Ventil Order No / Bestellnr.	Serie	RP	d3	d4	L	LI
HVK - 6 - DG 10	HK 6 DG 10	200	BSP 1/8"	17	9.5	40	30
HVK 6 DG 13	HK 6 DG 13	200	BSP 1/4"	17	9.5	43.6	30
HVK 6 DGM 14	HK 6 DGM 14	200	M14x1.5	17	9.5	43.6	30
HVK 6 DG 17	HK 6 DG 17	200	BSP 3/8"	17	9.5	43.6	30
HVK 9 DG 13	HK 9 DG 13	300	BSP 1/4"	23.3	13.5	52	40
HVK 9 DG 17	HK 9 DG 17	300	BSP 3/8"	23.3	13.5	52	40
HVK 9 DG 21	HK 9 DG 21	300	BSP 1/2"	23.3	13.5	57	40
HVK 16 DG 21	HK 16 DG 21	500	BSP 1/2"	32	20.1	75	57

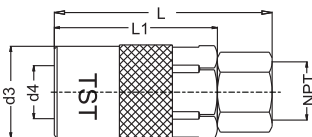

Female NPT Thread socket
Kupplung mit Innengewinde NPT



With Valve / Mit Ventil
Order No / Bestellnr.



Without Valve / Ohne Ventil
Order No / Bestellnr.

With Valve / Mit Ventil Order No / Bestellnr.	Without Valve / Ohne Ventil Order No / Bestellnr.	Serie	NPT	d3	d4	L	LI
HVK 6 NG 10	HK 6 NG 10	200	NPT 1/8"	17	9.5	42	30
HVK 6 NG 13	HK 6 NG 13	200	NPT 1/4"	17	9.5	45	30
HVK 9 NG 13	HK 9 NG 13	300	NPT 1/4"	23.3	13.5	55	40
HVK 9 NG 17	HK 9 NG 17	300	NPT 3/8"	23.3	13.5	55	40
HVK 16 NG 21	HK 16 NG 21	500	NPT 1/2"	32	20.1	77	57



SERIE 6,9,16

COUPLINGS, MULTICOUPLINGS & MOULD COOLING PRODUCTS

KUPPLUNGEN, MULTIKUPPLUNGEN & KÜHLUNGSELEMENTE FÜR WERKZEUGE

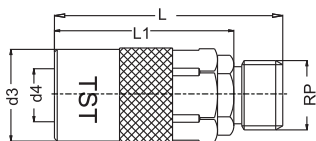

Cylindrical Thread male socket
Kupplung mit Aussengewinde zylindrisch BSP

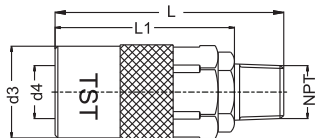

NPT Thread male socket
Kupplung mit Aussengewinde NPT

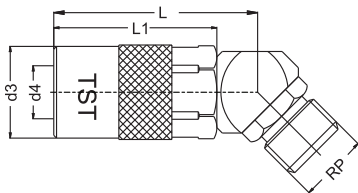

Cylindrical Thread male socket 45°
Kupplung mit 45°
Aussengewinde zylindrisch BSP



With Valve / Mit Ventil
Order No / Bestellnr.

Without Valve / Ohne Ventil
Order No / Bestellnr.

Serie	RP	d3	d4	L	LI
HVK 6 EG 10	BSP 1/8"	17	9.5	44	30
HVK 6 EG 13	BSP 1/4"	17	9.5	46	30
HVK 6 EGM 14	M14x1.5	17	9.5	46	30
HVK 6 EG 17	BSP 3/8"	17	9.5	46	30
HVK 9 EG 13	BSP 1/4"	23.3	13.5	56	45
HVK 9 EGM 16	M16x1.5	23.3	13.5	56	45
HVK 9 EG 17	BSP 3/8"	23.3	13.5	56	45
HVK 9 EGM 18	M18x1.5	23.3	13.5	57	45
HVK 9 EG 21	BSP 1/2"	23.3	13.5	58	45
HVK 16 EG 21	BSP 1/2"	32	20.1	78	66
HVK 16 EG 26	BSP 3/4"	32	20.1	82	66



With Valve / Mit Ventil
Order No / Bestellnr.

Without Valve / Ohne Ventil
Order No / Bestellnr.

Serie	NPT	d3	d4	L	LI
HVK 6 TG 10	NPT 1/8"	17	9.5	44	30
HVK 6 TG 13	NPT 1/4"	17	9.5	47	30
HVK 9 TG 13	NPT 1/4"	23.3	13.5	57	45
HVK 9 TG 17	NPT 3/8"	23.3	13.5	58	45
HVK 16 TG 21	NPT 1/2"	32	20.1	80	65



With Valve / Mit Ventil
Order No / Bestellnr.

Without Valve / Ohne Ventil
Order No / Bestellnr.

Serie	RP	d3	d4	L	LI
HVK 6 EG 10 - 45°	BSP 1/8"	17	9.5	38.3	30
HVK 6 EG 13 - 45°	BSP 1/4"	17	9.5	38.3	30
HVK 9 EG 13 - 45°	BSP 1/4"	23.3	13.5	48	40
HVK 9 EGM 16 - 45°	M16x1.5	23.3	13.5	48	40
HVK 9 EG 17 - 45°	BSP 3/8"	23.3	13.5	48	40
HVK 9 EG 21 - 45°	BSP 1/2"	23.3	13.5	48	40
HVK 16 EG 21 - 45°	BSP 1/2"	32	20.1	72.5	57

COUPLINGS, MULTICOUPLINGS & MOULD COOLING PRODUCTS

KUPPLUNGEN, MULTIKUPPLUNGEN & KÜHLUNGSELEMENTE FÜR WERKZEUGE

SERIE 6,9,16

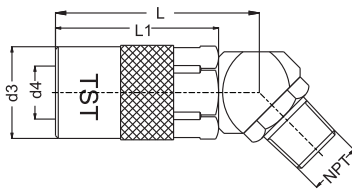

NPT Thread male socket 45°
Kupplung mit 45° Aussengewinde NPT



With Valve / Mit Ventil
Order No / Bestellnr.



Without Valve / Ohne Ventil
Order No / Bestellnr.

HVK 6 TG 10 - 45°
HVK 6 TG 13 - 45°
HVK 9 TG 13 - 45°
HVK 9 TG 17 - 45°
HVK 16 TG 21 - 45°

HK 6 TG 10 - 45°
HK 6 TG 13 - 45°
HK 9 TG 13 - 45°
HK 9 TG 17 - 45°
HK 16 TG 21 - 45°

Serie	NPT	d3	d4	L	LI
200	NPT 1/8"	17	9.5	38.3	30
200	NPT 1/4"	17	9.5	38.3	30
300	NPT 1/4"	23.3	13.5	48	40
300	NPT 3/8"	23.3	13.5	48	40
500	NPT 1/2"	32	20.1	72.5	57

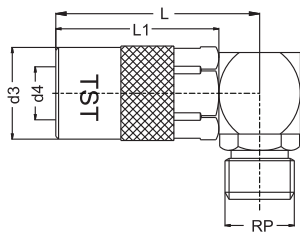

Cylindrical Thread male socket 90°
Kupplung mit 90°
Aussengewinde zylindrisch BSP



With Valve / Mit Ventil
Order No / Bestellnr.



Without Valve / Ohne Ventil
Order No / Bestellnr.

HVK 6 EG 10 - 90°
HVK 6 EG 13 - 90°
HVK 9 EG 13 - 90°
HVK 9 EGM 16 - 90°
HVK 9 EG 17 - 90°
HVK 9 EG 21 - 90°
HVK 16 EG 21 - 90°

HK 6 EG 10 - 90°
HK 6 EG 13 - 90°
HK 9 EG 13 - 90°
HK 9 EGM 16 - 90°
HK 9 EG 17 - 90°
HK 9 EG 21 - 90°
HK 16 EG 21 - 90°

Serie	RP	d3	d4	L	LI
200	BSP 1/8"	17	9.5	37.3	30
200	BSP 1/4"	17	9.5	37.3	30
300	BSP 1/4"	23.3	13.5	50	40
300	M16x1.5	23.3	13.5	50	40
300	BSP 3/8"	23.3	13.5	50	40
300	BSP 1/2"	23.3	13.5	50	40
500	BSP 1/2"	32	20.1	72	57

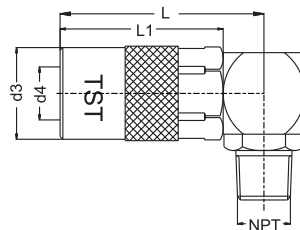

NPT Thread male socket 90°
Kupplung mit 90° Aussengewinde NPT



With Valve / Mit Ventil
Order No / Bestellnr.



Without Valve / Ohne Ventil
Order No / Bestellnr.

HVK 6 TG 10 - 90°
HVK 6 TG 13 - 90°
HVK 9 TG 13 - 90°
HVK 9 TG 17 - 90°
HVK 16 TG 21 - 90°

HK 6 TG 10 - 90°
HK 6 TG 13 - 90°
HK 9 TG 13 - 90°
HK 9 TG 17 - 90°
HK 16 TG 21 - 90°

Serie	NPT	d3	d4	L	LI
200	NPT 1/8"	17	9.5	37.3	30
200	NPT 1/4"	17	9.5	37.3	30
300	NPT 1/4"	23.3	13.5	50	40
300	NPT 3/8"	23.3	13.5	50	40
500	NPT 1/2"	32	20.1	72	57



COUPLINGS, MULTICOUPLINGS & MOULD COOLING PRODUCTS

SERIE 6,9,16

KUPPLUNGEN, MULTIKUPPLUNGEN & KÜHLUNGSELEMENTE FÜR WERKZEUGE



Blind Socket / Blindkupplung

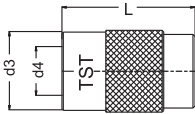

With Valve / Mit Ventil Order No / Bestellnr.	Serie	d3	d4	L
6 KTG 00	200	17	9.5	27
9 KTG 00	300	23.3	125	36

**Adapting Socket with Plug
Adapterkupplung mit Nippel**

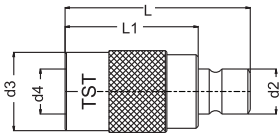

With Valve / Mit Ventil Order No / Bestellnr.	Without Valve / Ohne Ventil Order No / Bestellnr.	Serie	d2	d3	d4	L	LI
HVK 6 AU 09	HK 6 AU 09	200	13.5	17	9.5	47.6	30
HVK 9 AU 06	HK 9 AU 06	300	9.4	23.3	13.5	53	40

**Adapting Socket with 060 - 090 Plugs
Adapterkupplung mit 060 - 090 Nippel**

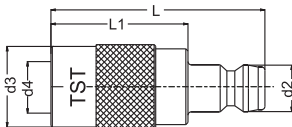

With Valve / Mit Ventil Order No / Bestellnr.	Without Valve / Ohne Ventil Order No / Bestellnr.	Serie	d2	d3	d4	L	LI
HVK 6 AU 090	HK 6 AU 090	200	9	17	9.5	46	30
HVK 9 AU 060	HK 9 AU 060	300	9	23.3	13.5	56.5	40

**Adapting Socket with 100.08 Plug
Adapterkupplung mit 100.08 Nippel**

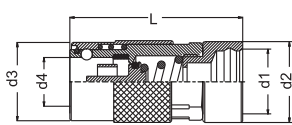

With Valve / Mit Ventil Order No / Bestellnr.	Without Valve / Ohne Ventil Order No / Bestellnr.	Serie	d1	d2	d3	d4	L
HVK 6 AU 100.08	HK 6 AU 100.08	200	17.1	21	17	9.5	51.6
HVK 9 AU 100.08	HK 9 AU 100.08	300	17.1	21	23.3	13.5	52

Adapting Plug / Adapternippel

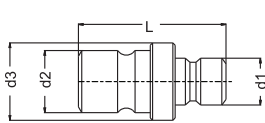

Order No / Bestellnr.	d1	d2	d3	L
9 HEF 06	9	13	15	32

Stop Plugs / Blindnippel

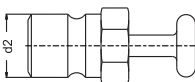

Order No / Bestellnr.	Serie	d2
6 KTU 00	200 (1/4")	9.4
9 KTU 00	300 (3/8")	13
16 KTU 00	500 (1/2")	19.9

Flexible Diverting connector / Umlenkupplung mit Schnellsteck- Schlauchtülle

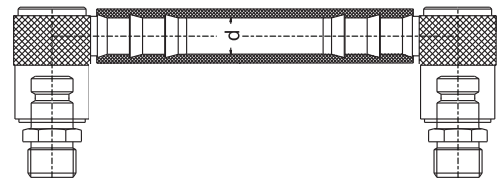
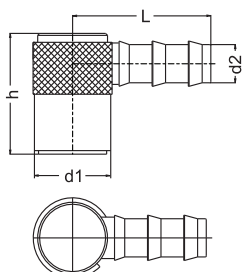

Order No Bestellnr.	Serie	Ød Hose Inner dia.	h		L		d1		d2	
			mm	inch.	mm	inch.	mm	inch.	mm	inch.
HK 6 KG 10	200	10 - 3/8"	28.3	1.11	34.5	1.35	17	0.67	10	0.394
HK 9 KG 13	300	13 - 1/2"	36.3	1.43	39.6	1.56	23	0.90	12.7	0.500

COUPLINGS, MULTICOUPLINGS & MOULD COOLING PRODUCTS
KUPPLUNGEN, MULTIKUPPLUNGEN & KÜHLUNGSELEMENTE FÜR WERKZEUGE

SERIE 6,9,16



Diverging connector / Umlenkkupplung

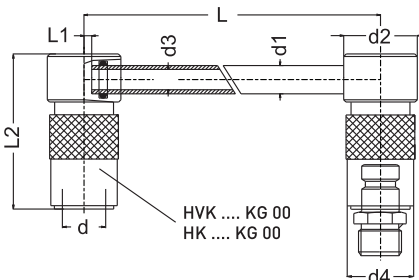

With Valve / Mit Ventil
Order No / Bestellnr.

Without Valve / Ohne Ventil
Order No / Bestellnr.

Order No / Bestellnr.	Series	d	d1	d2	d3	d4	LI	L2	L
HVK 6 - KG 125	200	9.5	8	20	6	17	0	44	125
HVK 6 - KG 250	200	9.5	8	20	6	17	0	44	250
HVK 6 - KG 500	200	9.5	8	20	6	17	0	44	500
HVK 9 - KG 125	300	13.5	10	26	8	22.5	2	41	125
HVK 9 - KG 250	300	13.5	10	26	8	22.5	2	41	250
HVK 9 - KG 500	300	13.5	10	26	8	22.5	2	41	500
HVK 16 - KG 160	500	20	14	36	12	31	2	55	160
HVK 16 - KG 315	500	20	14	36	12	31	2	55	315
HVK 16 - KG 500	500	20	14	36	12	31	2	55	500

**Push-Lock Hose Plug
Stecknippel mit
Schnellsteck - Schlauchtülle**

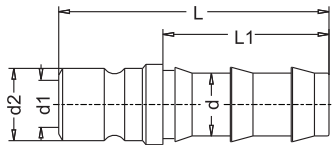

Order No / Bestellnr.	Series	d / I.D		d1	d2	LI		L	
		mm	inch.			mm	inch.	mm	inch.
6 FU 10	200	10	3/8"	6	9.4	24	0.95	37	1.45
6 FU 13	200	12.7	1/2"	6	9.4	28	1.10	41	1.61
9 FU 10	300	10	3/8"	9	13.5	24	0.95	45	1.75
9 FU 13	300	12.7	1/2"	9	13.5	28	1.10	48	1.86
16 FU 13	500	12.7	1/2"	15	19.9	28	1.10	55	2.16
16 FU 19	500	19	3/4"	15	19.9	38	1.50	65	2.55

**Standard Hose plug
Standard Schlauchtülle**

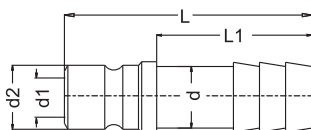

Order No / Bestellnr.	Series	d	d1	d2	L	LI
6 HU 06	200	6.3 - 1/4"	6	9.4	37	23
6 HU 08	200	8 - 5/16"	6	9.4	37	23
6 HU 09	200	9 - 5/14"	6	9.4	37	23
6 HU 10	200	10 - 3/8"	6	9.4	37	23
9 HU 09	300	9 - 5/14"	9	13.5	37	25.3
9 HU 10	300	10 - 3/8"	9	13.5	45	25.3
9 HU 11	300	11 - 7/16"	9	13.5	45	25.3
9 HU 13	300	13 - 1/2"	9	13.5	45	25.3
16 HU 13	500	13.3 - 1/4"	15	19.9	45	27
16 HU 20	500	20 - 3/4"	15	19.9	50	27



SERIE 6,9,16

COUPLINGS, MULTICOUPLINGS & MOULD COOLING PRODUCTS

KUPPLUNGEN, MULTIKUPPLUNGEN & KÜHLUNGSELEMENTE FÜR WERKZEUGE



Plug with conical male thread
Nippel mit konischem Aussengewinde

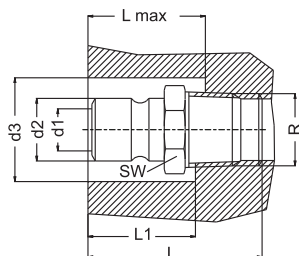

Order No / Bestellnr.		Serie	R	dl	d2	d3	SW	LI	L max	L
BSPT	NPT									
6 RU 10	6 TU 10	200	1/8"	6	9.4	22	11	15	18	24
6 RU 13	6 TU 13	200	1/4"	6	9.4	26	14	15	18	27
6 RU 17	6 TU 17	200	3/8"	6	9.4	30	17	15	22	27
9 RU 10	9 TU 10	300	1/8"	9	13.5	26	14	20.5	24	29.5
9 RU 13	9 TU 13	300	1/4"	9	13.5	26	14	20.5	26	32.5
9 RU 17	9 TU 17	300	3/8"	9	13.5	30	17	20.5	28	32.5
9 RU 21	9 TU 21	300	1/2"	9	13.5	37	22	24.5	28	37
16 RU 13	16 TU 13	500	1/4"	15	20	36	21	24.5	28	36.5
16 RU 17	16 TU 17	500	3/8"	15	20	36	21	24.5	29	37.5
16 RU 21	16 TU 21	500	1/2"	15	20	37	22	25.5	36	42.5
16 RU 26	16 TU 26	500	3/4"	15	20	42	27	26	36	43.8

Plug with cylindrical male thread
Nippel mit zylindrisches Außengewinde

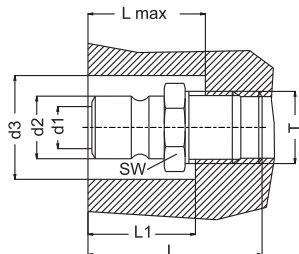

Order No / Bestellnr.	Serie	T	dl	d2	d3	SW	LI	L max	L
9 EU 13	300	BSP 1/4"	9	13.5	26	14	20.5	20.5	29.5
9 EU 17	300	BSP 3/8"	9	13.5	32	19	20.5	20.5	29.5
16 EU 17	500	BSP 3/8"	15	20	36	21	26	26	35
16 EU 21	500	BSP 1/2"	15	20	37	22	25.5	25.5	37.5
6 EUM 10	200	M10X1	6	9.4	22	11	15	15	24
6 EUM 14	200	M14X1.5	6	9.4	26	15	15	15	25
9 EUM 10	300	M10X1	9	13.5	26	14	20.5	20.5	29.5
9 EUM 14	300	M14X1.5	9	13.5	26	15	20.5	20.5	29.5

Shut-off Male threaded plug
Verschlussnippel mit Außengewinde

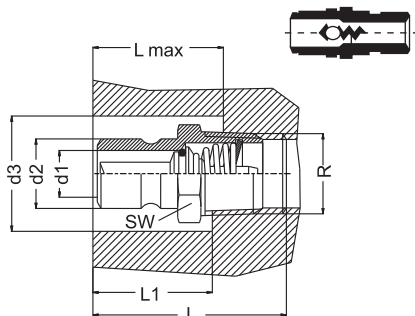

Order No / Bestellnr.		Serie	R	dl	d2	d3	SW	LI	L max	L
BSPT	NPT									
6 RUB 13	6 TUB 13	200	1/4"	6	9.4	26	14	15	24	29
6 RUB 17	6 TUB 17	200	3/8"	6	9.4	30	17	15	24	29
9 RUB 13	9 TUB 13	300	1/4"	9	13.5	26	14	20.5	24	32.5
9 RUB 17	9 TUB 17	300	3/8"	9	13.5	30	17	20.5	24	32.5
9 RUB 21	9 TUB 21	300	1/2"	9	13.5	37	22	21	30	37
16 RUB 21	16 TUB 21	500	1/2"	15	20	37	22	26.7	36	45.5
16 RUB 26	16 TUB 26	500	3/4"	15	20	42	27	26.7	36	45.5

Order No / Bestellnr.	Serie	R	dl	d2	d3	SW	LI	L max	L
6 EUBM 14	200	M14x1.5	6	9.4	26	14	15	15	29
9 EUBM 14	300	M14x1.5	9	13.5	26	14	20	20	30

Plug with female thread
Nippel mit Innengewinde

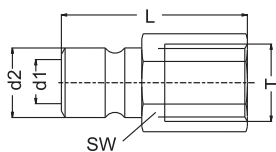

Order No / Bestellnr.		Serie	T	d1	d2	L	SW
BSP	NPT						
6 DU 10	6 NU 10	200	1/8"	6	9.4	25.5	13
6 DU 13	6 NU 13	200	1/4"	6	9.4	32	16
6 DU 17	6 NU 17	200	3/8"	6	9.4	32	19
9 DU 10	9 NU 10	300	1/8"	9	13.5	29	14
9 DU 13	9 NU 13	300	1/4"	9	13.5	37	16
9 DU 17	9 NU 17	300	3/8"	9	13.5	39	19
9 DU 21	9 NU 21	300	1/2"	9	13.5	40	24
16 DU 17	16 NU 17	500	3/8"	15	20	34.5	24
16 DU 21	16 NU 21	500	1/2"	15	20	34.5	24

COUPLINGS, MULTICOUPLINGS & MOULD COOLING PRODUCTS

KUPPLUNGEN, MULTIKUPPLUNGEN & KÜHLUNGSELEMENTE FÜR WERKZEUGE

■ **SERIE 6,9,16**



Long Threaded Plugs / Gewindestecker

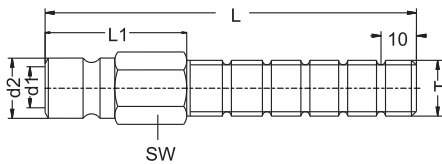

Order No / Bestellnr.	Serie	T	d1	d2	SW	LI	L
6 BLM 10x100	200	M10x1	6	9.4	11	40	100
6 BL 10x100	200	BSP 1/8"	6	9.4	11	40	100
6 BL 13x100	200	BSP 1/4"	6	9.4	14	40	100
6 BLM 14x100	200	M14x1.5	6	9.4	14	40	100
6 BL 17x100	200	BSP 3/8"	6	9.4	17	40	100
9 BLM 10x100	300	M10x1	9	13.5	14	40	100
9 BL 10x100	300	BSP 1/8"	9	13.5	14	40	100
9 BL 13x100	300	BSP 1/4"	9	13.5	14	40	100
9 BLM 14x100	300	M14x1.5	9	13.5	14	40	100
9 BLM 16x100	300	M16x1.5	9	13.5	16	40	100
9 BL 17x100	300	BSP 3/8"	9	13.5	17	40	100

Extension plug without thread / Verlängerungsniessel ohne Gewinde

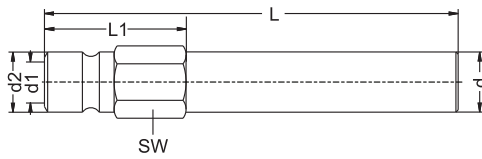

Order No / Bestellnr.	Serie	d	d1	d2	SW	L	LI
6 BN 63	200	10	6	9.4	11	63	17
6 BN 100	200	10	6	9.4	11	100	17
6 BN 120	200	10	6	9.4	11	120	17
6 BN 240	200	10	6	9.4	11	240	17
6 BN 360	200	10	6	9.4	11	360	17
9 BN 150	300	14	9	13.5	15	150	23.5
9 BN 300	300	14	9	13.5	15	300	23.5
9 BN 450	300	14	9	13.5	15	450	24
16 BN 500	500	21	15	20	22	500	31.5
16 BN 800	500	21	15	20	22	800	31.5

Extension plug / Verlängerungsniessel

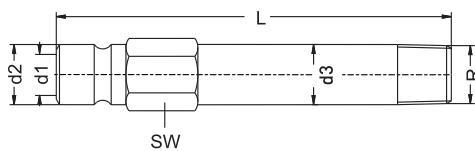

Order No / Bestellnr.		Serie	R	SW	d1	d2	d3	L50	L100	L150	L200	L250
BSPT	NPT											
6 RU 10xL	6 TU 10xL	200	1/8"	11	6	9.4	10	50	100	150	200	250
6 RU 13xL	6 TU 13xL	200	1/4"	14	6	9.4	13.5	50	100	150	200	250
6 RU 17xL	6 TU 17xL	200	3/8"	17	6	9.4	16.8	50	100	150	200	250
9 RU 13xL	9 TU 13xL	300	1/4"	15	9	13.5	14	50	100	150	200	250
9 RU 17xL	9 TU 17xL	300	3/8"	17	9	13.5	16.8	50	100	150	200	250

Order No / Bestellnr.	Serie	R	SW	d1	d2	d3	L50	L100	L150	L200	L250
6 EUM 10xL	200	M10x1	11	6	9	10	50	100	150	200	250
6 EUM 14xL	200	M14x1.5	15	6	9	14	50	100	150	200	250
9 EUM 14xL	300	M14x1.5	15	9	13	14	50	100	150	200	250

Angle plug with 90° / Winkelniessel mit 90°

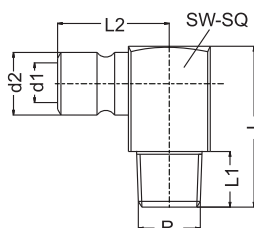

Order No / Bestellnr.	Serie	R	d1	d2	L	LI	L2	SW /SQ
6 RU 10 - 90	200	BSPT 1/8"	6	9.4	27	9	19.5	11
6 EUM 10 - 90	200	M10x1	6	9.4	27	9	19.5	11
6 RU 13 - 90	200	BSPT 1/4"	6	9.4	34	12	21	15
6 EUM 14 - 90	200	M14x1.5	6	9.4	34	12	21	15
6 RU 17 - 90	200	BSPT 3/8"	6	9.4	34	12	24	17
9 RU 13 - 90	300	BSPT 1/4"	9	13.5	34	12	24	15
9 RU 17 - 90	300	BSPT 3/8"	9	13.5	34	12	24	17



SERIE 6,9,16 ■

COUPLINGS, MULTICOUPLINGS & MOULD COOLING PRODUCTS

KUPPLUNGEN, MULTIKUPPLUNGEN & KÜHLUNGSELEMENTE FÜR WERKZEUGE

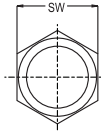
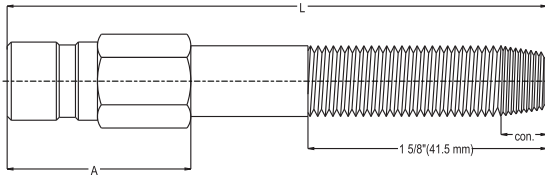

Extension Plugs with tapered and long parallel thread
Verlängerungsrippel mit Aussengewinde konisch

The largest complete thread on the standard NPT or BSPT taper is continued along the extension plug for the 1 5/8" (41.5 mm) shown below easy adjustments if needed. Die erste Gewindestufe der konisch ausgeführten Nippel ermöglicht einen sehr flexiblen Einsatzbereich

Serie & Thread	Order No / Bestellnr.		A		L	
	NPT	BSPT	mm	inch.	mm	inch.
300 1/8"	9 NL 10x63	9 RL 10x63	21	7/8"	63.5	2.5"
	9 NL 10x101	9 RL 10x101	25.4	1"	101.6	4"
	9 NL 10x140	9 RL 10x140	25.4	1"	140	5.5"
	9 NL 10x178	9 RL 10x178	25.4	1"	178	7"
	9 NL 10x216	9 RL 10x216	25.4	1"	216	8.5"
	9 NL 10x254	9 RL 10x254	25.4	1"	254	10"
	9 NL 10x292	9 RL 10x292	25.4	1"	292	11.5"
	9 NL 10x330	9 RL 10x330	25.4	1"	330	13"
	6 NL 10x63	6 RL 10x63	21.2	11/16"	63.5	2.5"
6 NL 10x101	6 RL 10x101	25.4	1"	101.6	4"	
6 NL 10x140	6 RL 10x140	25.4	1"	140	5.5"	
6 NL 10x178	6 RL 10x178	25.4	1"	178	7"	
6 NL 10x216	6 RL 10x216	25.4	1"	216	8.5"	
6 NL 10x254	6 RL 10x254	25.4	1"	254	10"	
6 NL 10x292	6 RL 10x292	25.4	1"	292	11.5"	
6 NL 10x330	6 RL 10x330	25.4	1"	330	13"	
300 1/4"	9 NL 13x63	9 RL 13x63	22.2	7/8"	63.5	2.5"
	9 NL 13x101	9 RL 13x101	31.7	1.25"	101.6	4"
	9 NL 13x140	9 RL 13x140	31.7	1.25"	140	5.5"
	9 NL 13x178	9 RL 13x178	31.7	1.25"	178	7"
	9 NL 13x216	9 RL 13x216	31.7	1.25"	216	8.5"
	9 NL 13x254	9 RL 13x254	31.7	1.25"	254	10"
	9 NL 13x292	9 RL 13x292	31.7	1.25"	292	11.5"
	9 NL 13x330	9 RL 13x330	31.7	1.25"	330	13"
	6 NL 13x63	6 RL 13x63	22.2	7/8"	63.5	2.5"
6 NL 13x101	6 RL 13x101	31.7	1.25"	101.6	4"	
6 NL 13x140	6 RL 13x140	31.7	1.25"	140	5.5"	
6 NL 13x178	6 RL 13x178	31.7	1.25"	178	7"	
6 NL 13x216	6 RL 13x216	31.7	1.25"	216	8.5"	
6 NL 13x254	6 RL 13x254	31.7	1.25"	254	10"	
6 NL 13x292	6 RL 13x292	31.7	1.25"	292	11.5"	
6 NL 13x330	6 RL 13x330	31.7	1.25"	330	13"	
300 3/8"	9 NL 17x63	9 RL 17x63	25.4	1"	63.5	2.5"
	9 NL 17x101	9 RL 17x101	31.7	1.25"	101.6	4"
	9 NL 17x140	9 RL 17x140	31.7	1.25"	140	5.5"
	9 NL 17x178	9 RL 17x178	31.7	1.25"	178	7"
	9 NL 17x216	9 RL 17x216	31.7	1.25"	216	8.5"
	9 NL 17x254	9 RL 17x254	31.7	1.25"	254	10"
	9 NL 17x292	9 RL 17x292	31.7	1.25"	292	11.5"
	9 NL 17x330	9 RL 17x330	31.7	1.25"	330	13"
	6 NL 17x63	6 RL 17x63	25.4	1"	63.5	2.5"
6 NL 17x101	6 RL 17x101	31.7	1.25"	101.6	4"	
6 NL 17x140	6 RL 17x140	31.7	1.25"	140	5.5"	
6 NL 17x178	6 RL 17x178	31.7	1.25"	178	7"	
6 NL 17x216	6 RL 17x216	31.7	1.25"	216	8.5"	
6 NL 17x254	6 RL 17x254	31.7	1.25"	254	10"	
6 NL 17x292	6 RL 17x292	31.7	1.25"	292	11.5"	
6 NL 17x330	6 RL 17x330	31.7	1.25"	330	13"	
300 1/2"	9 NL 21x63	9 RL 21x63	25.4	1"	63.5	2.5"
	9 NL 21x101	9 RL 21x101	31.7	1.25"	101.6	4"
	9 NL 21x140	9 RL 21x140	31.7	1.25"	140	5.5"
	9 NL 21x178	9 RL 21x178	31.7	1.25"	178	7"
	9 NL 21x216	9 RL 21x216	31.7	1.25"	216	8.5"
	9 NL 21x254	9 RL 21x254	31.7	1.25"	254	10"
	9 NL 21x292	9 RL 21x292	31.7	1.25"	292	11.5"
	9 NL 21x330	9 RL 21x330	31.7	1.25"	330	13"
	6 NL 21x63	6 RL 21x63	25.4	1"	63.5	2.5"
6 NL 21x101	6 RL 21x101	31.7	1.25"	101.6	4"	
6 NL 21x140	6 RL 21x140	31.7	1.25"	140	5.5"	
6 NL 21x178	6 RL 21x178	31.7	1.25"	178	7"	
6 NL 21x216	6 RL 21x216	31.7	1.25"	216	8.5"	
6 NL 21x254	6 RL 21x254	31.7	1.25"	254	10"	
6 NL 21x292	6 RL 21x292	31.7	1.25"	292	11.5"	
6 NL 21x330	6 RL 21x330	31.7	1.25"	330	13"	
500 3/8"	16 NL 17x63	16 RL 17x63	28.5	1.25"	63.5	2.5"
	16 NL 17x101	16 RL 17x101	35	1.5"	101.6	4"
	16 NL 17x140	16 RL 17x140	35	1.5"	140	5.5"
	16 NL 17x178	16 RL 17x178	35	1.5"	178	7"
	16 NL 17x216	16 RL 17x216	35	1.5"	216	8.5"
	16 NL 17x254	16 RL 17x254	35	1.5"	254	10"
	16 NL 17x292	16 RL 17x292	35	1.5"	292	11.5"
	16 NL 17x330	16 RL 17x330	35	1.5"	330	13"
	16 NL 21x63	16 RL 21x63	28.5	1.25"	63.5	2.5"
16 NL 21x101	16 RL 21x101	38	1.5"	101.6	4"	
16 NL 21x140	16 RL 21x140	38	1.5"	140	5.5"	
16 NL 21x178	16 RL 21x178	38	1.5"	178	7"	
16 NL 21x216	16 RL 21x216	38	1.5"	216	8.5"	
16 NL 21x254	16 RL 21x254	38	1.5"	254	10"	
16 NL 21x292	16 RL 21x292	38	1.5"	292	11.5"	
16 NL 21x330	16 RL 21x330	38	1.5"	330	13"	

COUPLINGS, MULTICOUPLINGS & MOULD COOLING PRODUCTS

KUPPLUNGEN, MULTIKUPPLUNGEN & KÜHLUNGSELEMENTE FÜR WERKZEUGE

SERIE 6,9,16



Steel Extension Tube / Verlängerungsrohr aus Stahl

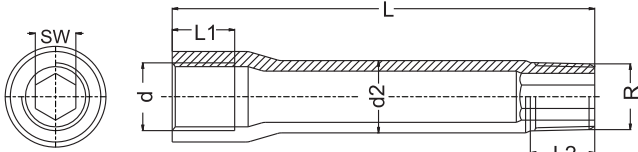

Order No / Bestellnr.		d	R	d2	L	LI	L2	SW
BSP / BSPT	NPT / NPT							
R 10 BU 50	N 10 BU 50	1/8"	1/8"	10	50	12	10	5
R 10 BU 75	N 10 BU 75	1/8"	1/8"	10	75	12	10	5
R 10 BU 100	N 10 BU 100	1/8"	1/8"	10	100	12	10	5
R 10 BU 125	N 10 BU 125	1/8"	1/8"	10	125	12	10	5
R 13 BU 50	N 13 BU 50	1/4"	1/4"	14	50	12	11	8
R 13 BU 75	N 13 BU 75	1/4"	1/4"	14	75	12	11	8
R 13 BU 100	N 13 BU 100	1/4"	1/4"	14	100	12	11	8
R 13 BU 125	N 13 BU 125	1/4"	1/4"	14	125	12	11	8
R 13 BU 150	N 13 BU 150	1/4"	1/4"	14	150	12	11	8

Extension tube / Verlängerungsrohr

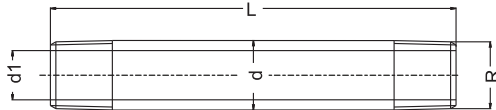

Standard : Steel Zinc Plated - Stahl Verzinkt
Option : Brass Nickel Plated - Messing Vernickelt

Order No / Bestellnr.		R	d	d1	L
BSPT	NPT				
6 BU 50	6 NBU 50	1/8"	10	6	50
6 BU 100	6 NBU 100	1/8"	10	6	100
6 BU 150	6 NBU 150	1/8"	10	6	150
6 BU 200	6 NBU 200	1/8"	10	6	200
6 BU 250	6 NBU 250	1/8"	10	6	250
9 BU 50	9 NBU 50	1/4"	14	9	50
9 BU 100	9 NBU 100	1/4"	14	9	100
9 BU 150	9 NBU 150	1/4"	14	9	150
9 BU 200	9 NBU 200	1/4"	14	9	200
9 BU 250	9 NBU 250	1/4"	14	9	250
12 BU 100	12 NBU 100	3/8"	17	12	100
12 BU 150	12 NBU 150	3/8"	17	12	150
12 BU 200	12 NBU 200	3/8"	17	12	200
12 BU 250	12 NBU 250	3/8"	17	12	250
16 BU 100	16 NBU 100	1/2"	22	16	100
16 BU 150	16 NBU 150	1/2"	22	16	150
16 BU 200	16 NBU 200	1/2"	22	16	200
16 BU 250	16 NBU 250	1/2"	22	16	250

Spare seal/ Ersatz O-Ring (NBR +100°C)



Order No / Bestellnr.	Serie	Temperature
CG 6 N	N 6	
CG 9 N	N 9	-10° /100° C
CG 16 N	N 16	-4° F / +212° F

Spare seal - Ersatz O-Ring Viton (V)



Order No / Bestellnr.	Serie	Temperature
CG 6 V	N 6	
CG 9 V	N 9	-20° /200° C
CG 16 V	N 16	-14° F / +392° F